

measurements
and
cross-sections

Karpathos, Lefkós.
Local potters ①

HSI-1Aa

ΦΙΛΟΞΕΝΟΥ

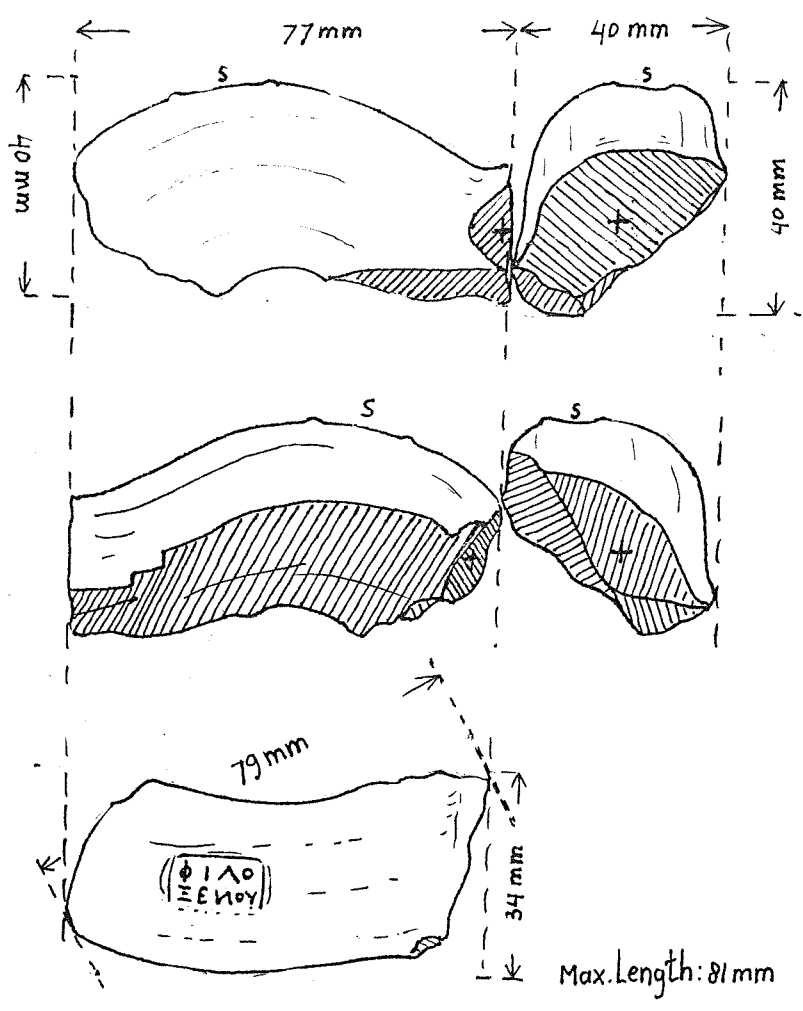

S = STAMP (...S = position stamp on back-side)
 ▨ = fracture-surface
 + = corresponding surfaces left/right
 ■ = central cavity

P.S.

Karpathos, Lefkós
Local potters ②

HSI-1Ba

ΦΙΛΟΞΕΝΟΥ

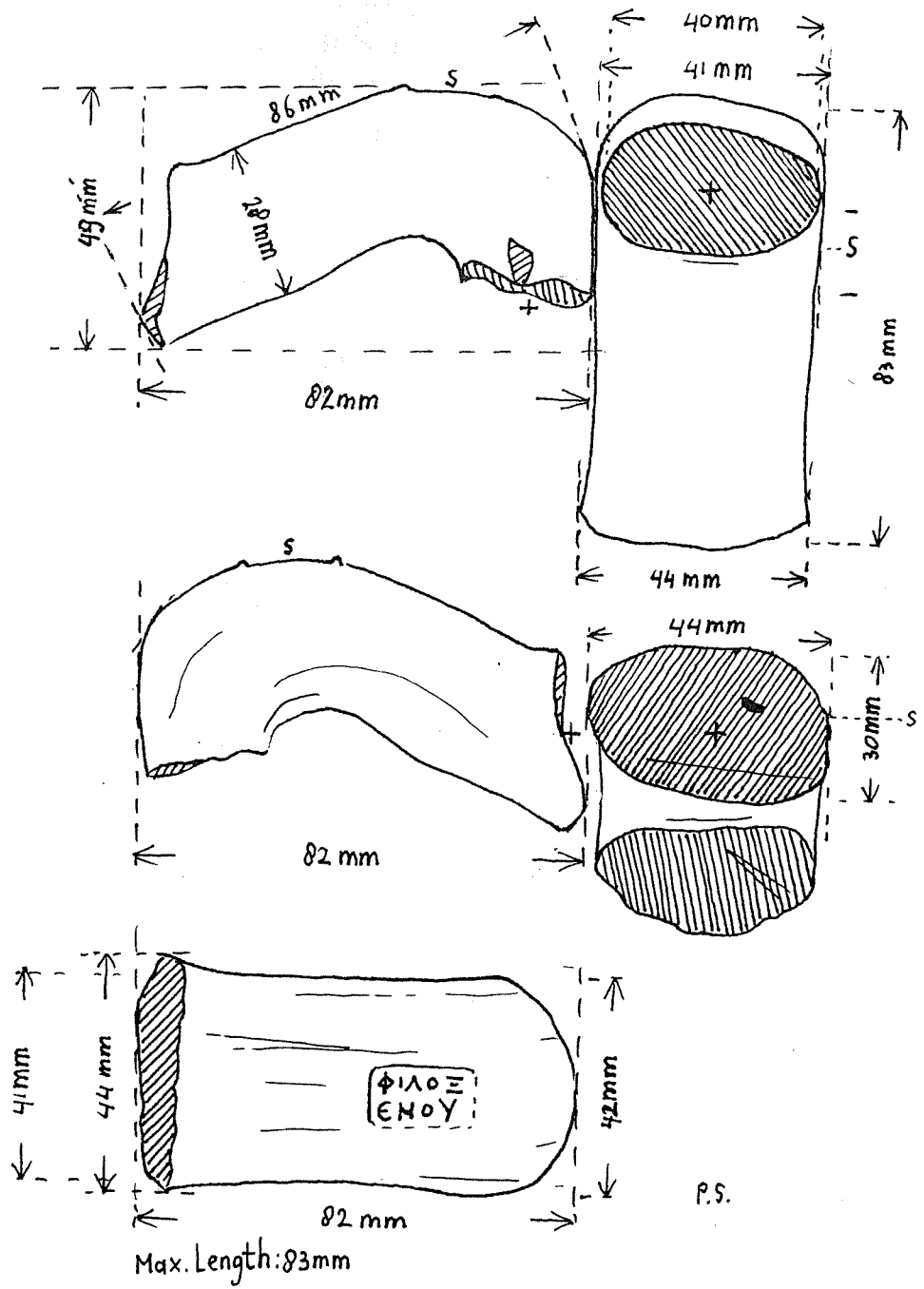

Karpathos, Lefkós
Local potters ③

HSI-2Aa

ΑΤΤΙΝΑΣ
(porous clay)

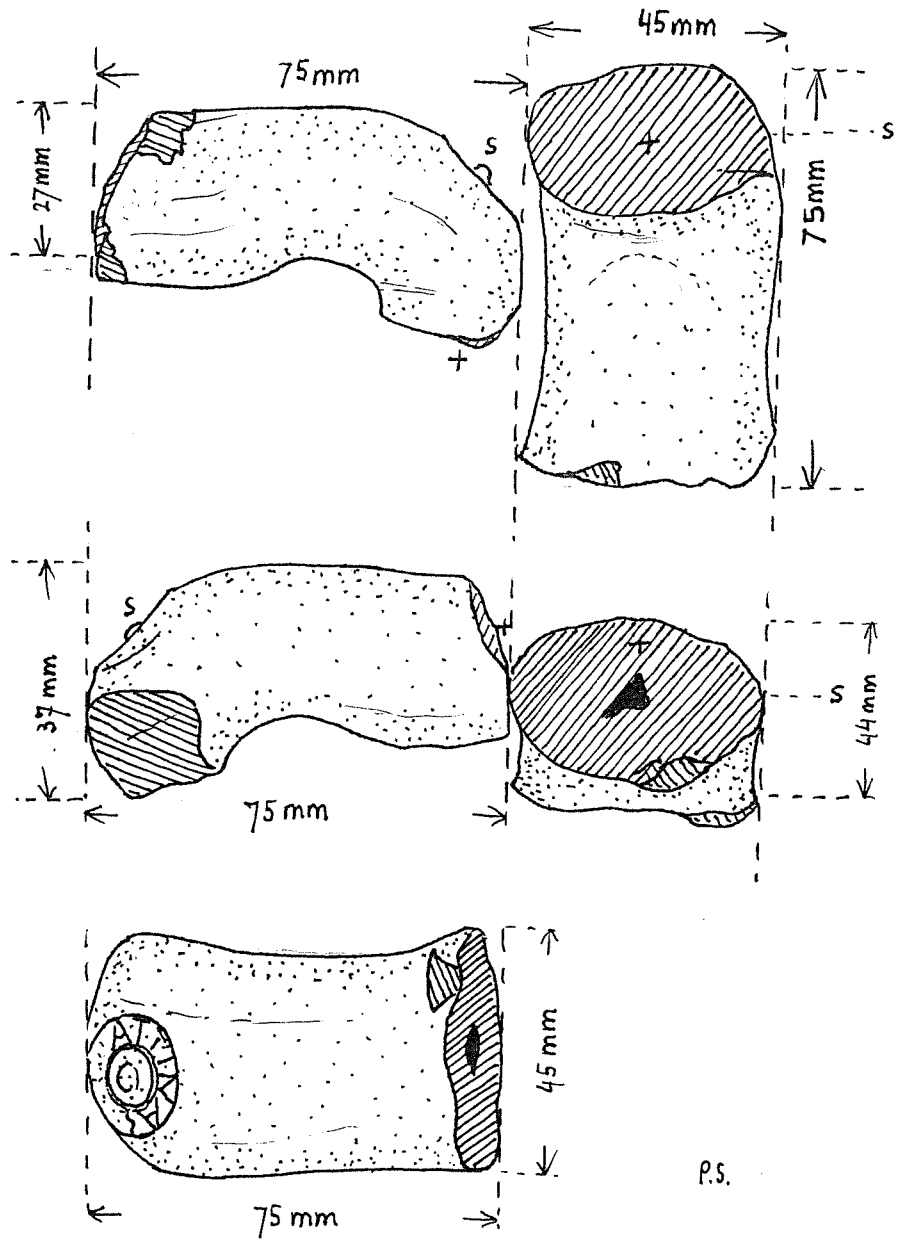

P.S.

Max. Length: 77 mm

Karpathos - Lefkós
Local potters (4)

HSI-2Ac

ATTINΑΣ
(compact clay)

(Leaf 1)

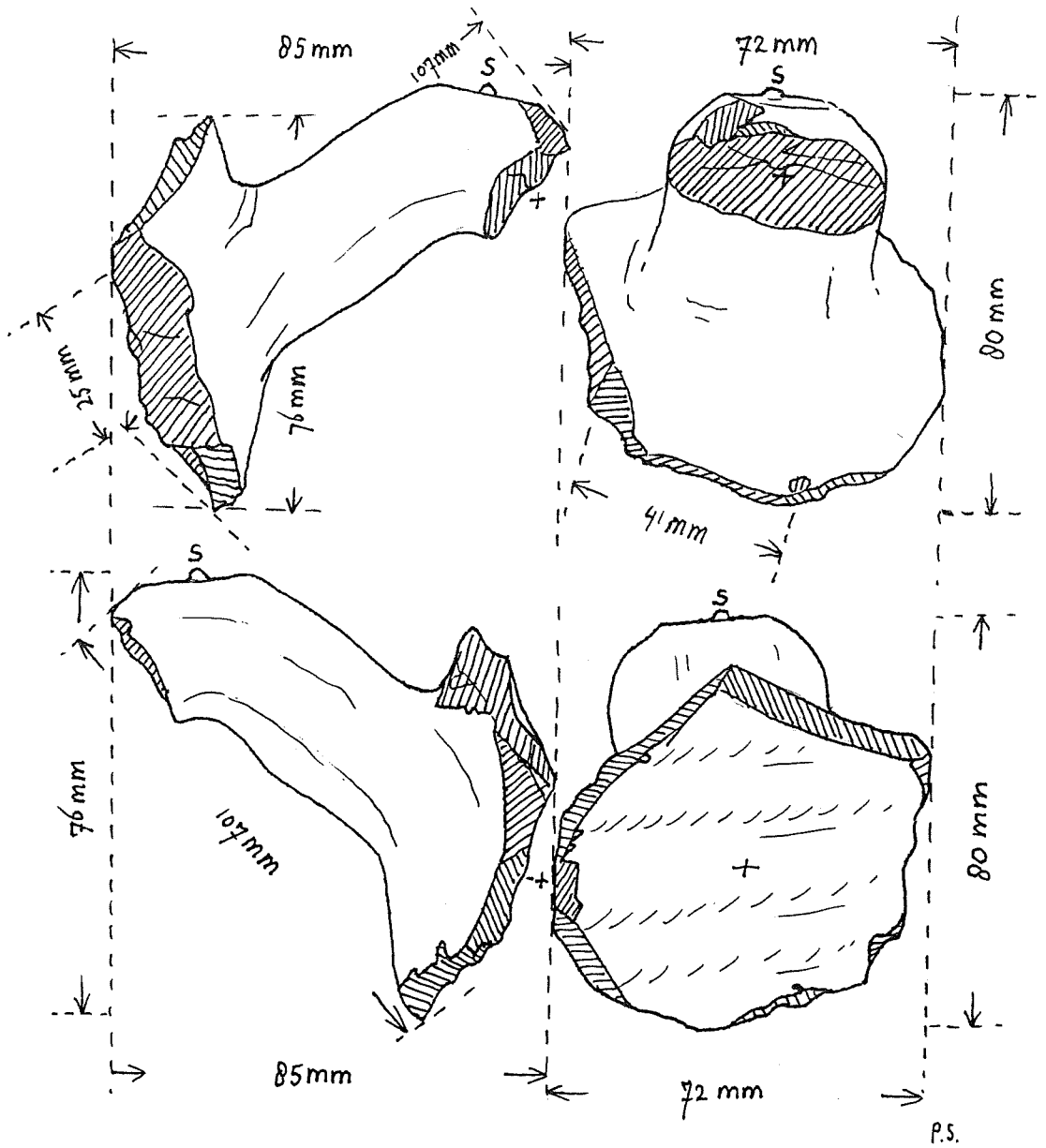

Karpathos - Lefkos
Local potters (4)

HSI - 2Ac

ATTINAE (Leaf 2)

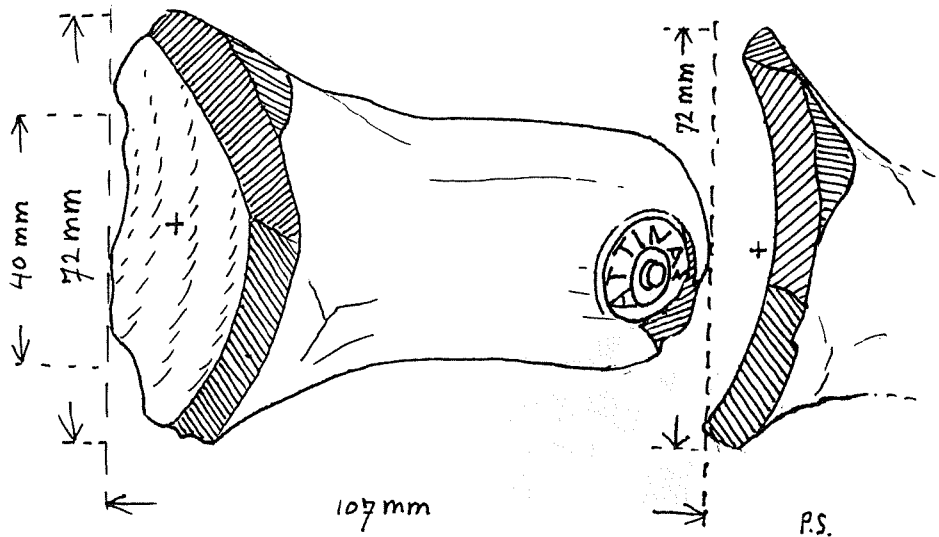
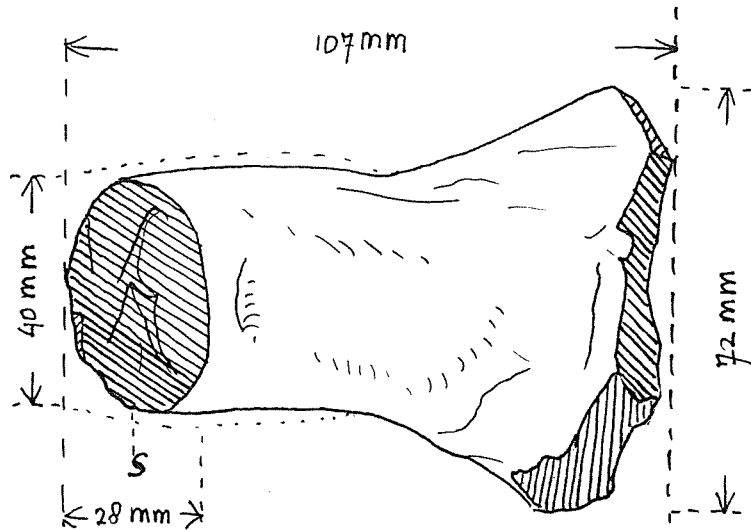

Max. Length: 107 mm.

Karpathos, Lefkós
Local potters ⑤

HSI-3Aa

ΛΥΚΕΙΝΟΥ

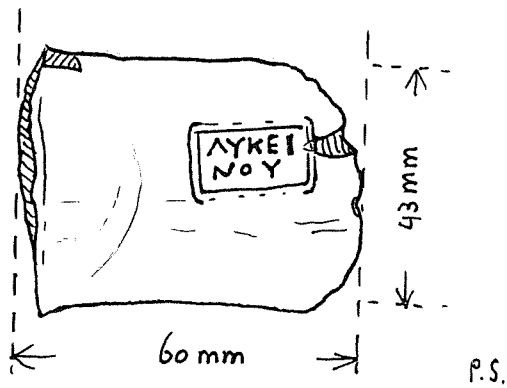
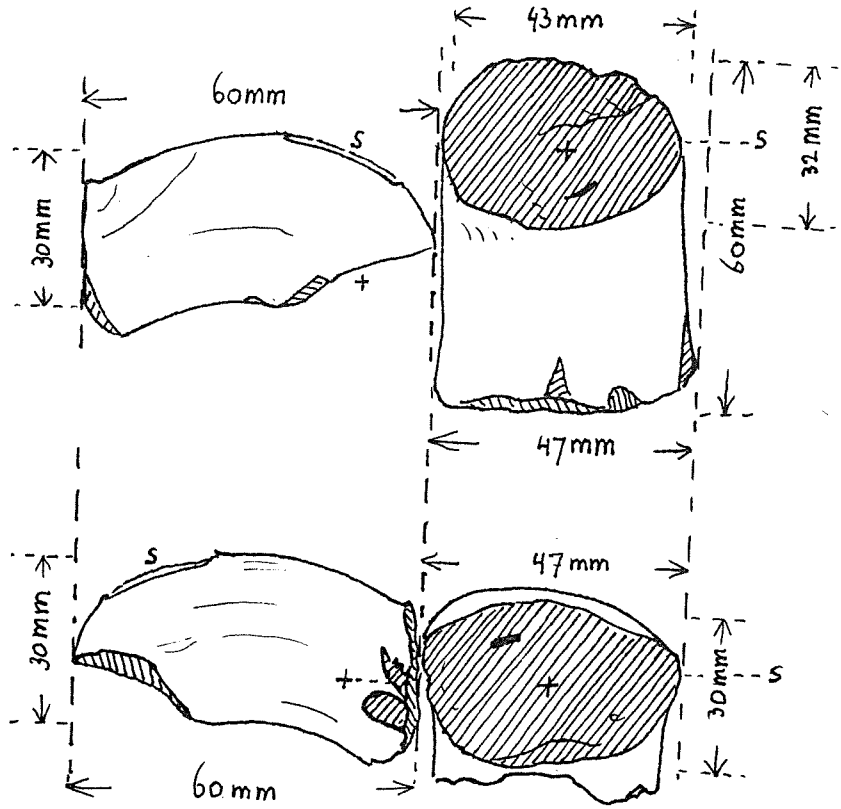

Max. Length: 64mm.

Karpathos, Lefkós
Local potters ⑥

HSI-3Bb

ΛΥΚΙΝΟΥ

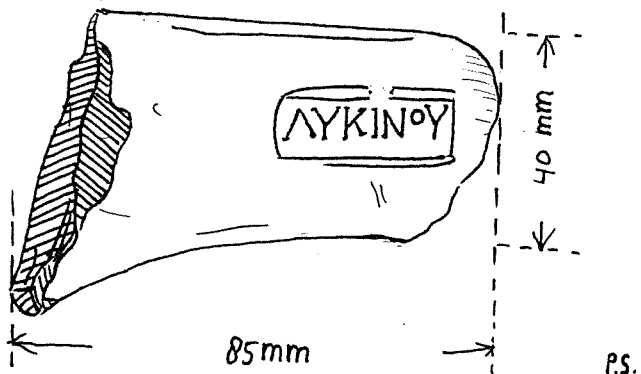
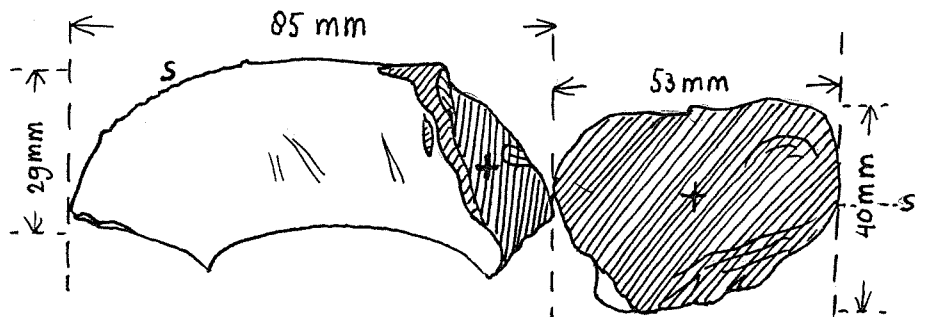
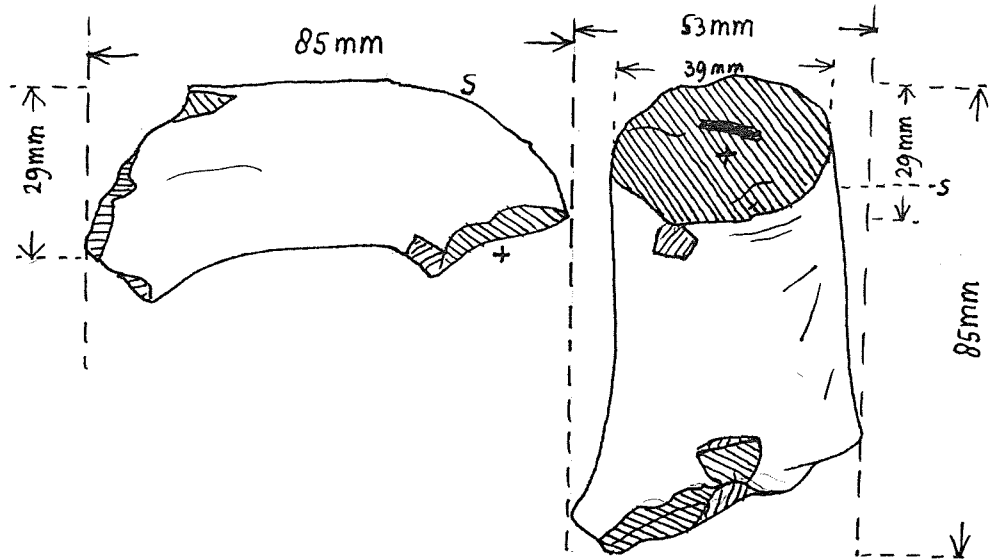

Max. Length: 89 mm.

P.S.

Karpathos, Lefkós
Local potters (7)

HS1-3Ca

ΛΥΚΙΝΟΥ

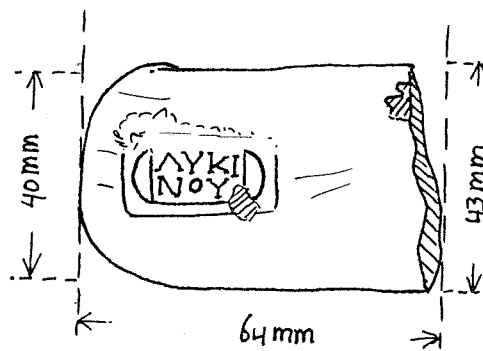
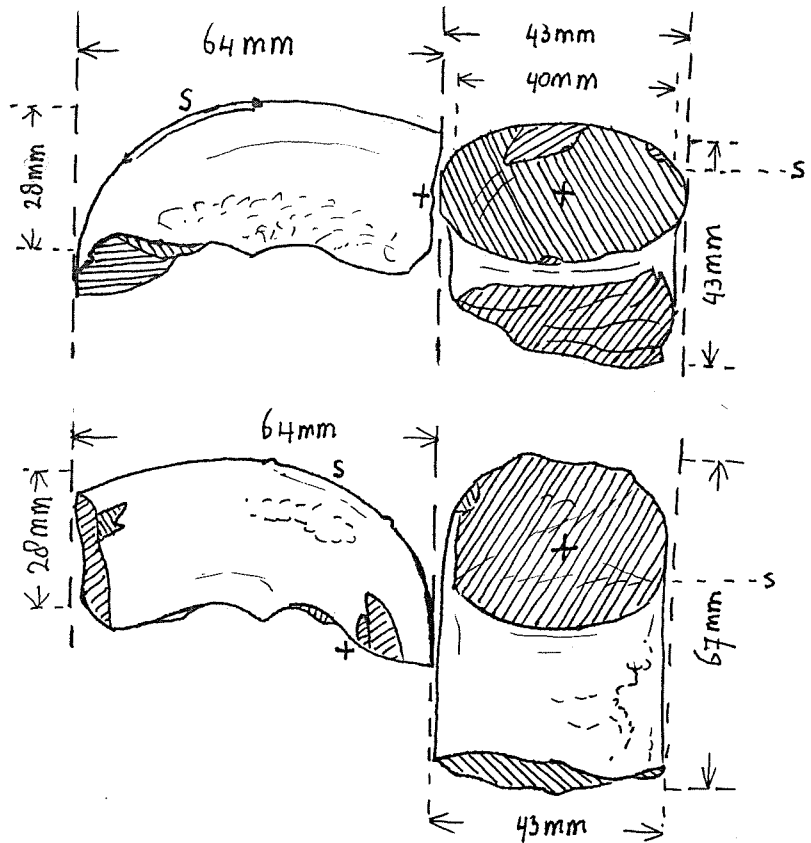

Max.Length: 69 mm.

P.S.

Karpathos, Lefkós
Local potters (8)

HSI-6Aa

ΔΕΞΙΚΡ(ΑΤΕΥΣ)
(Leaf 1)

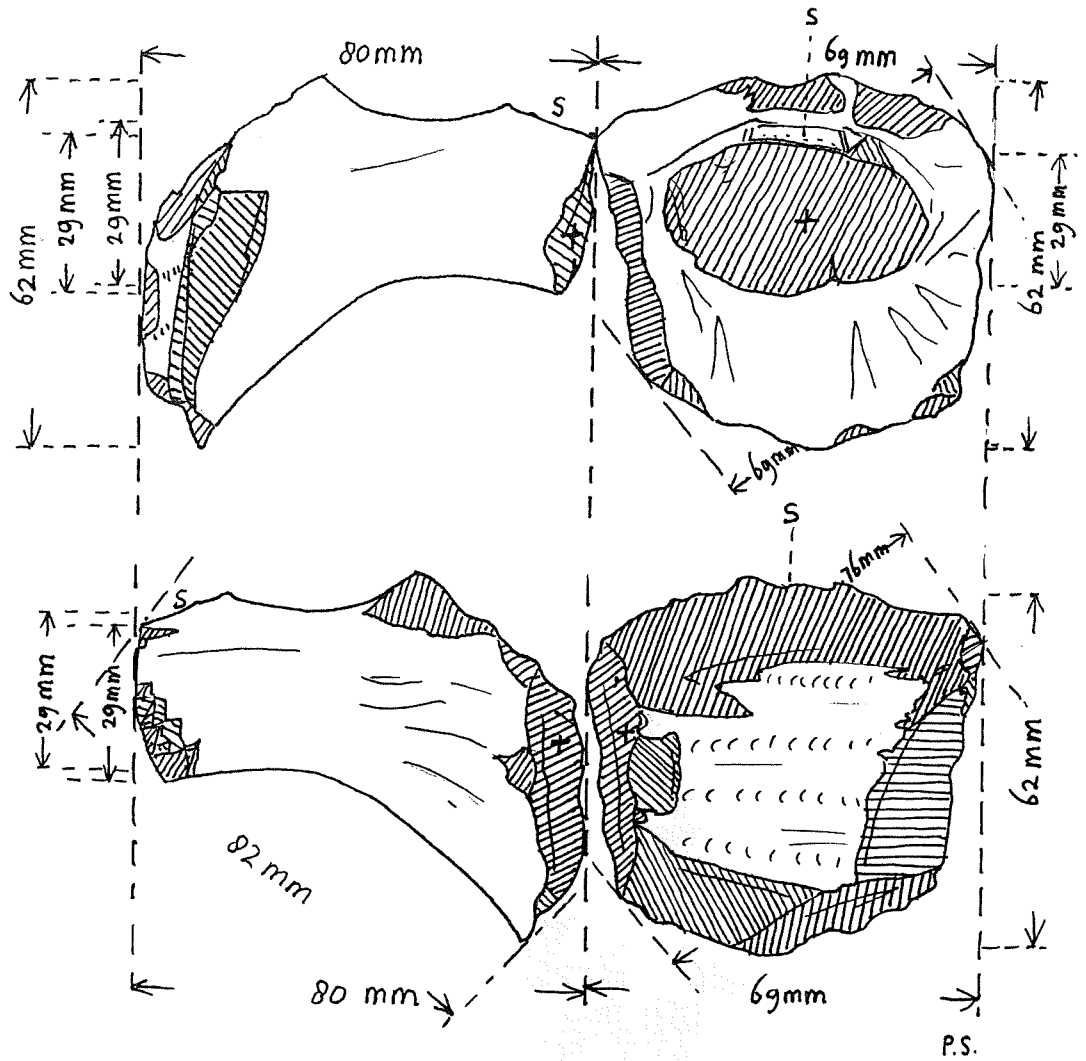

Karpathos, Lefkós
Local potters (8)

HSI-6Aa

ΔΕΞΙΚΡ(ΑΤΕΥΣ)
(Leaf 2)

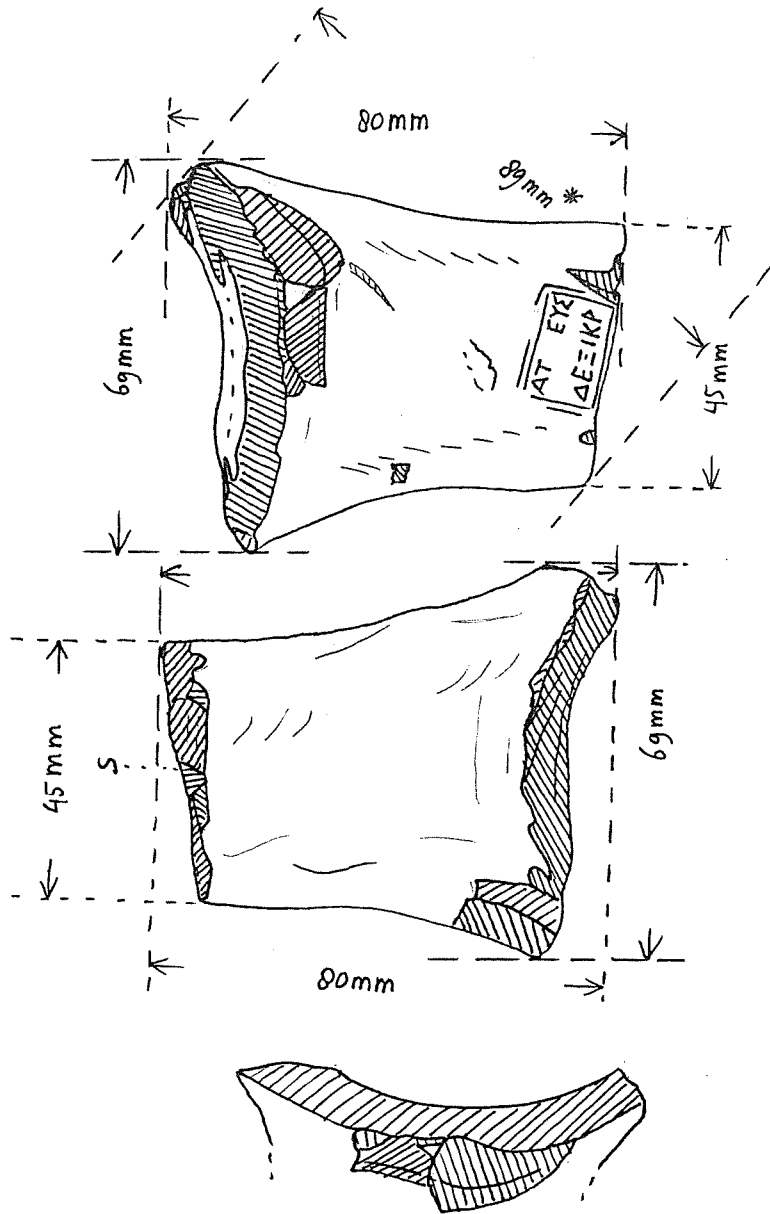

* Max. Length: 92 mm.

P.S.

Karpathos, Lefkós

HSI-6A-type

ΔΕΞΙΚΡ(ΑΤΕΥΣ)

Local potters (8^a)

Rim-fragment of a big jar

(Leaf 1)

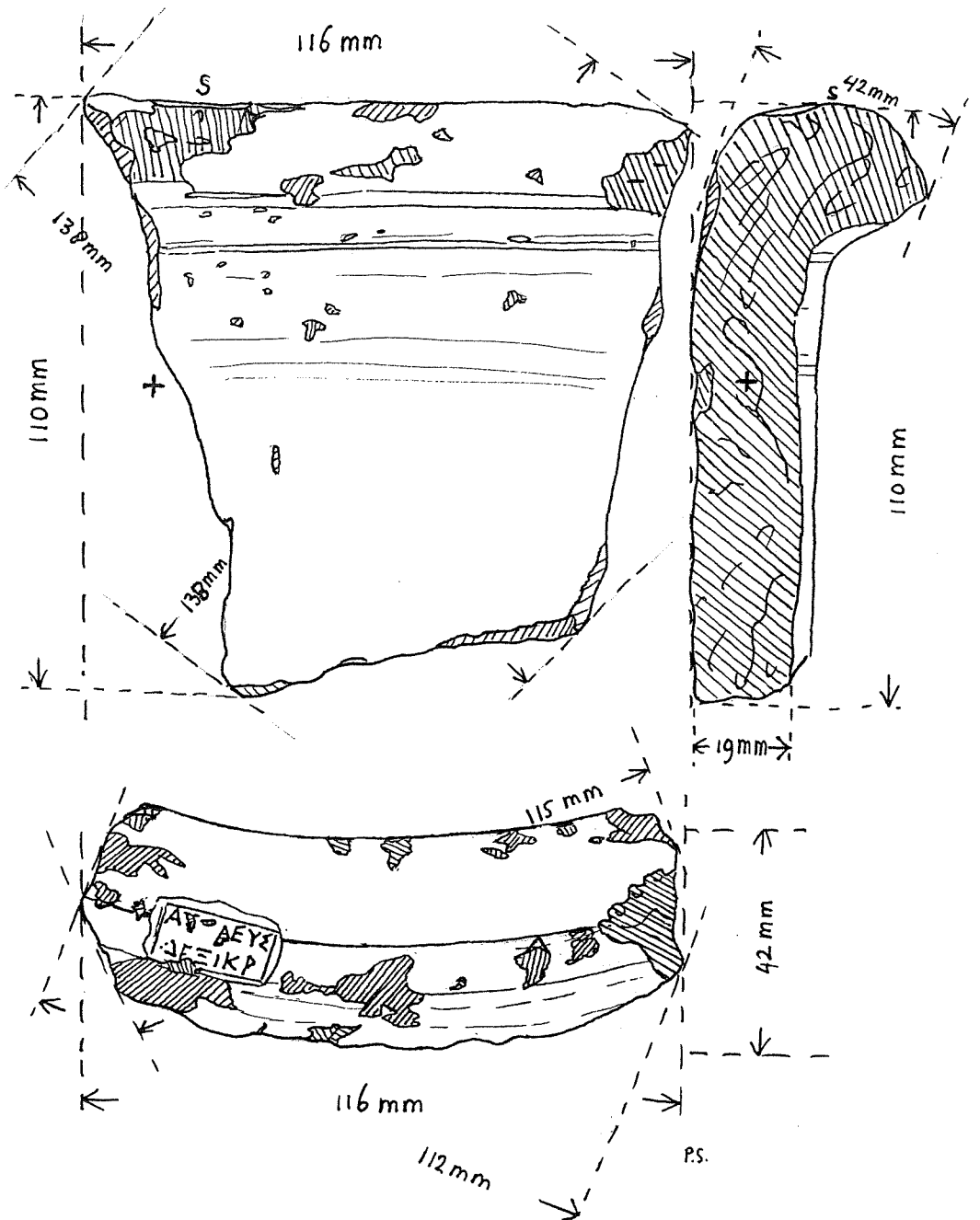

Karpathos, Lefkós
Local potters (8^a)

HSI-6A-type
Rim-fragment of a big jar

ΔΕΞΙΚΡ(ΑΤΕΥΣ)
(Leaf 2)

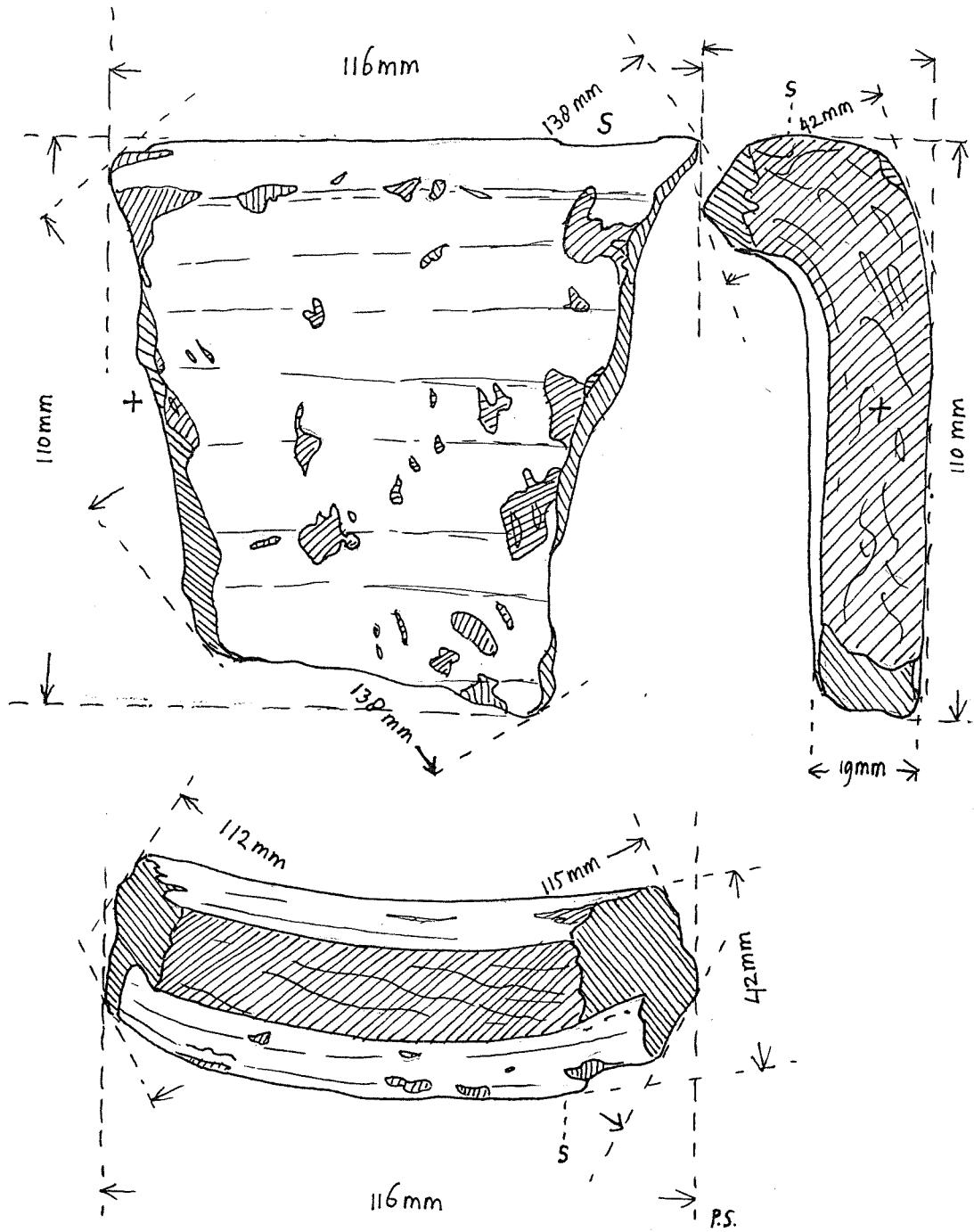

Karpathos, Lefkós
Local potters (9)

HSI-1C-type

ΦΙΛΟΞΕΝΟΥ
(mirrored)

Scale 1:1

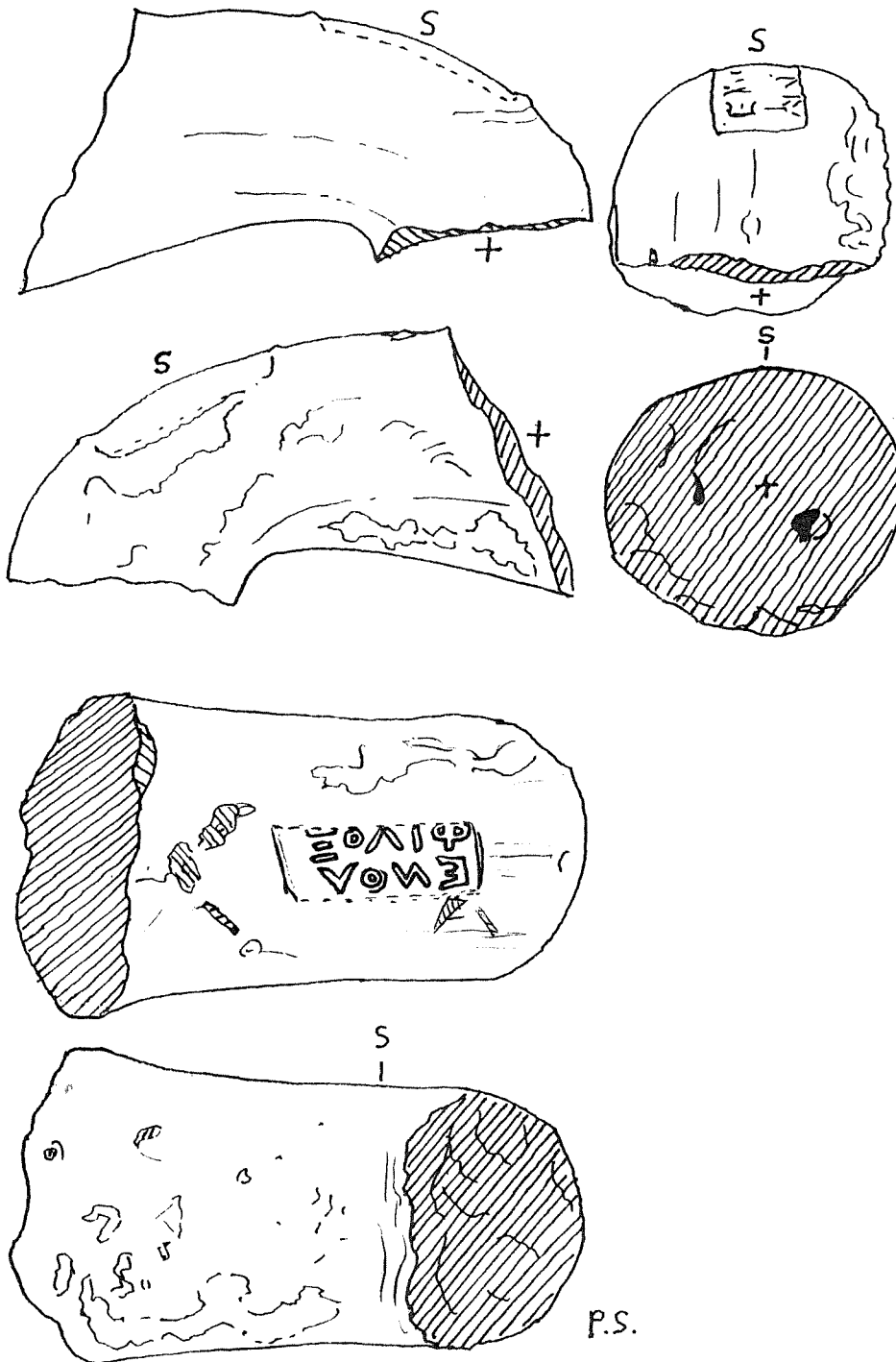

N.B. To ensure readability, slight damage at the stamp has not been taken into account.

Karpathos - Zefkós

HSI +1Ba

ΦΙΛΟΞΕΝΟΥ

Local potters (10)

scale 1:1

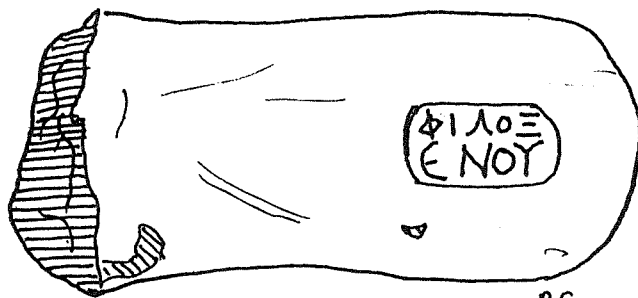
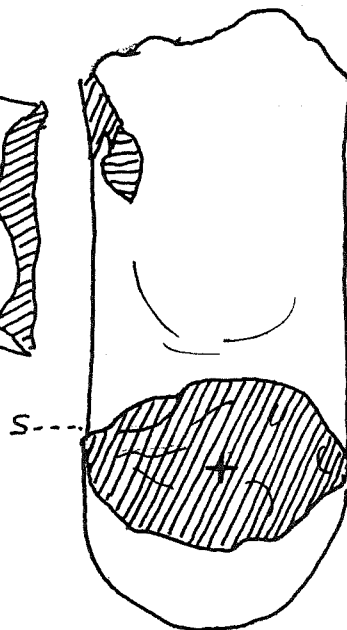
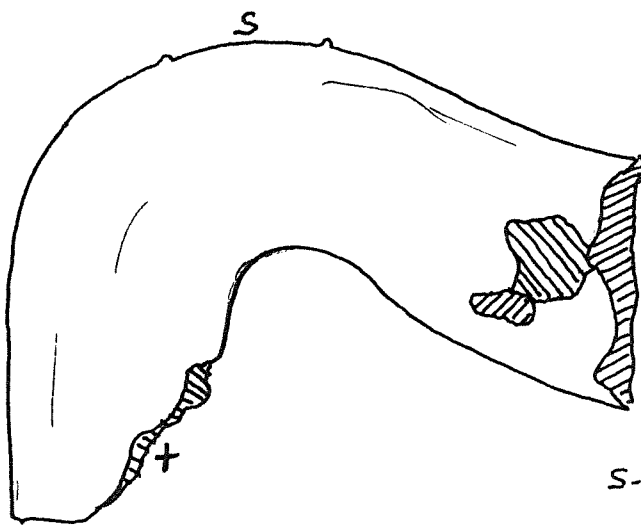
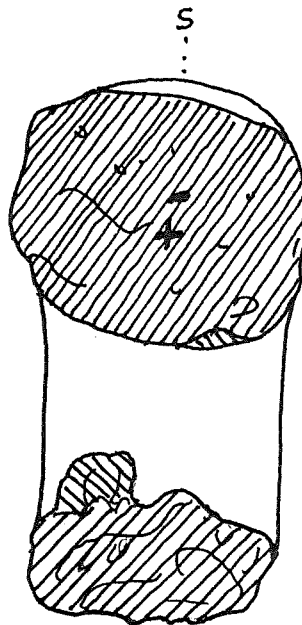
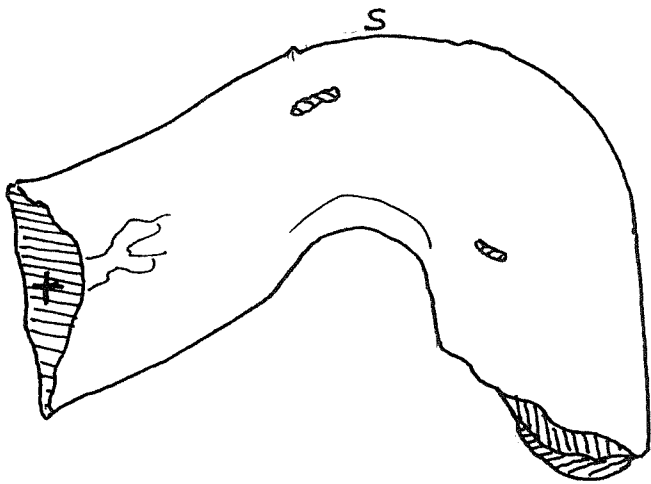

P.S.

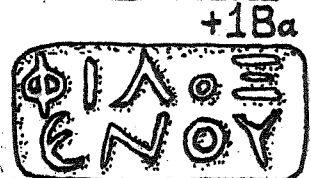
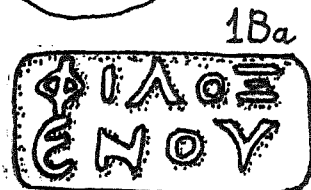

Karpathos, Lefkós - Palace Area (HS1)
Amphora-bottom-points (the most typical kinds)

Leaf one

(Scale 1:1)

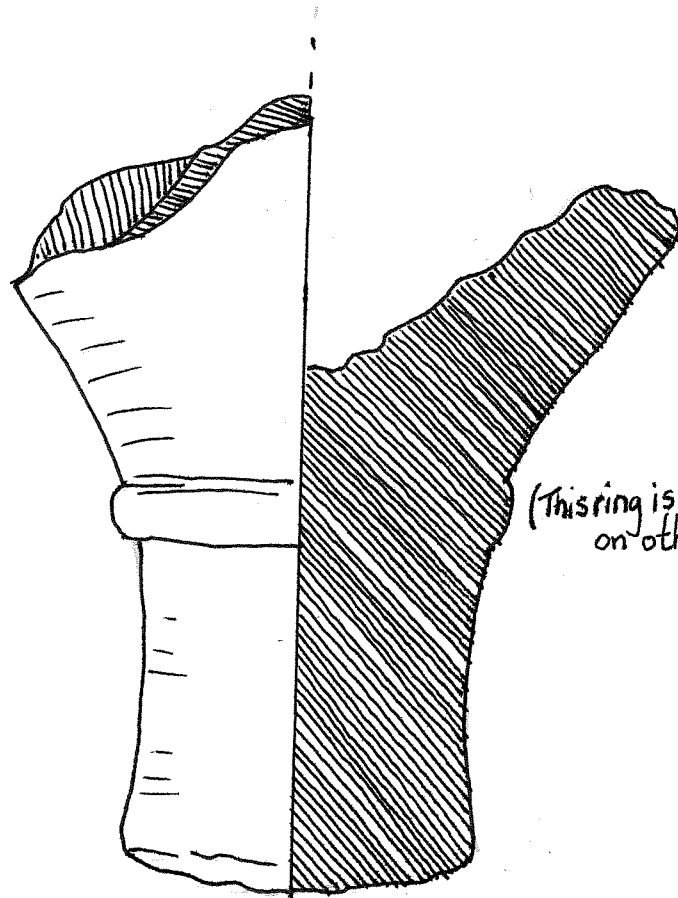

(This ring is not always so clear)
on other examples

①

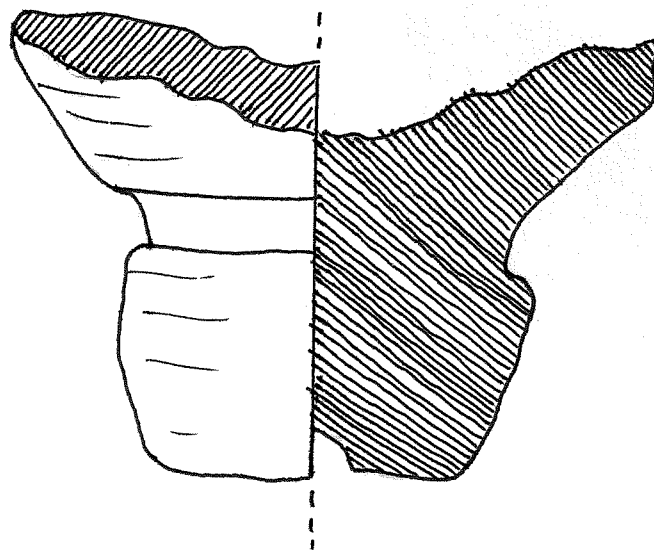

②

(scale 1:1)

Leaf two

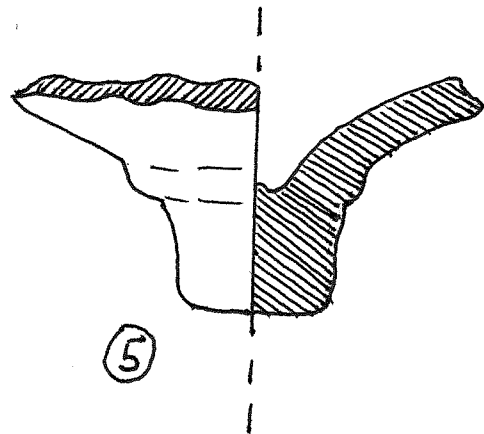
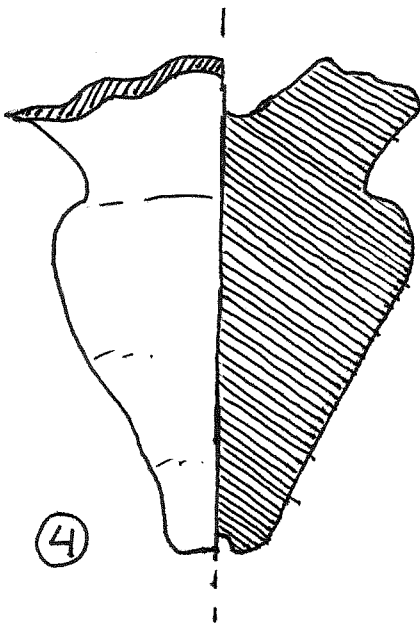
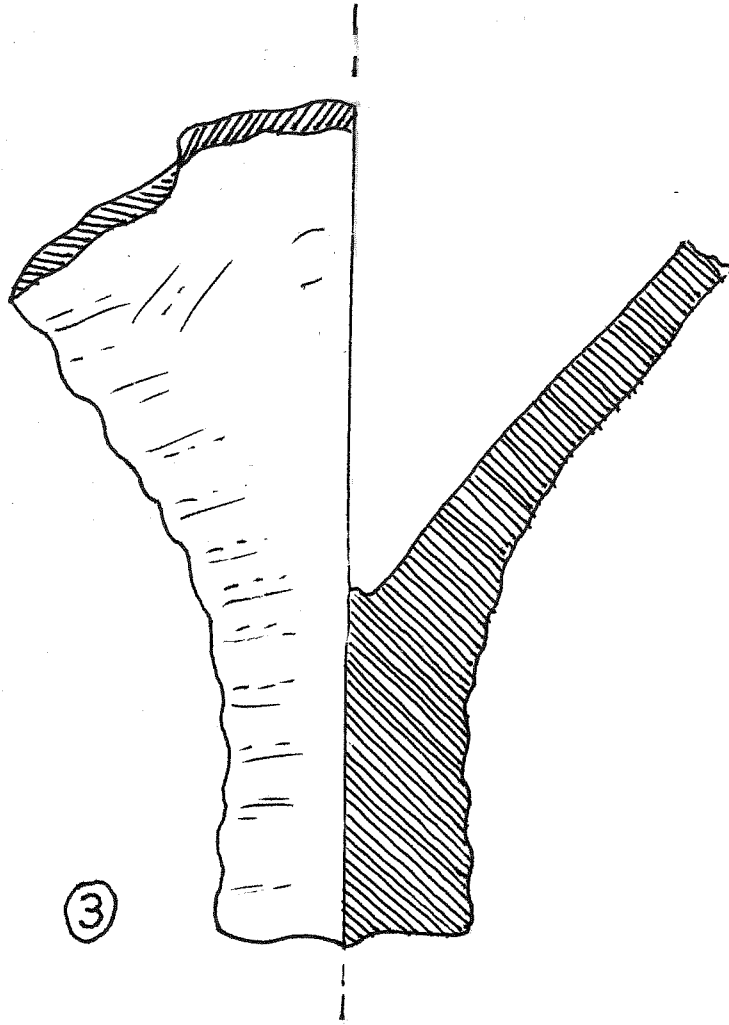

of these examples, types 1, 2 and 3 are most frequently present

HS I - Fragment from a platform-like object (pottery-wheel?) Leaf 1

scale 1:1

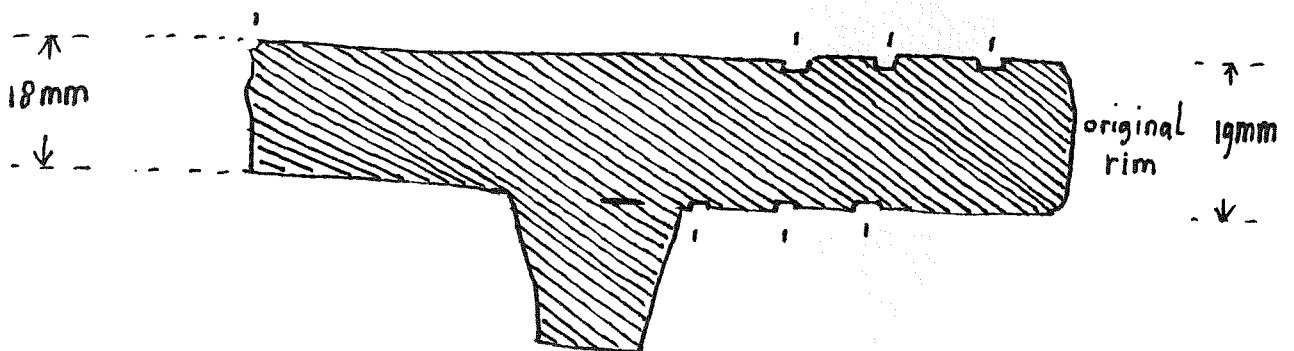
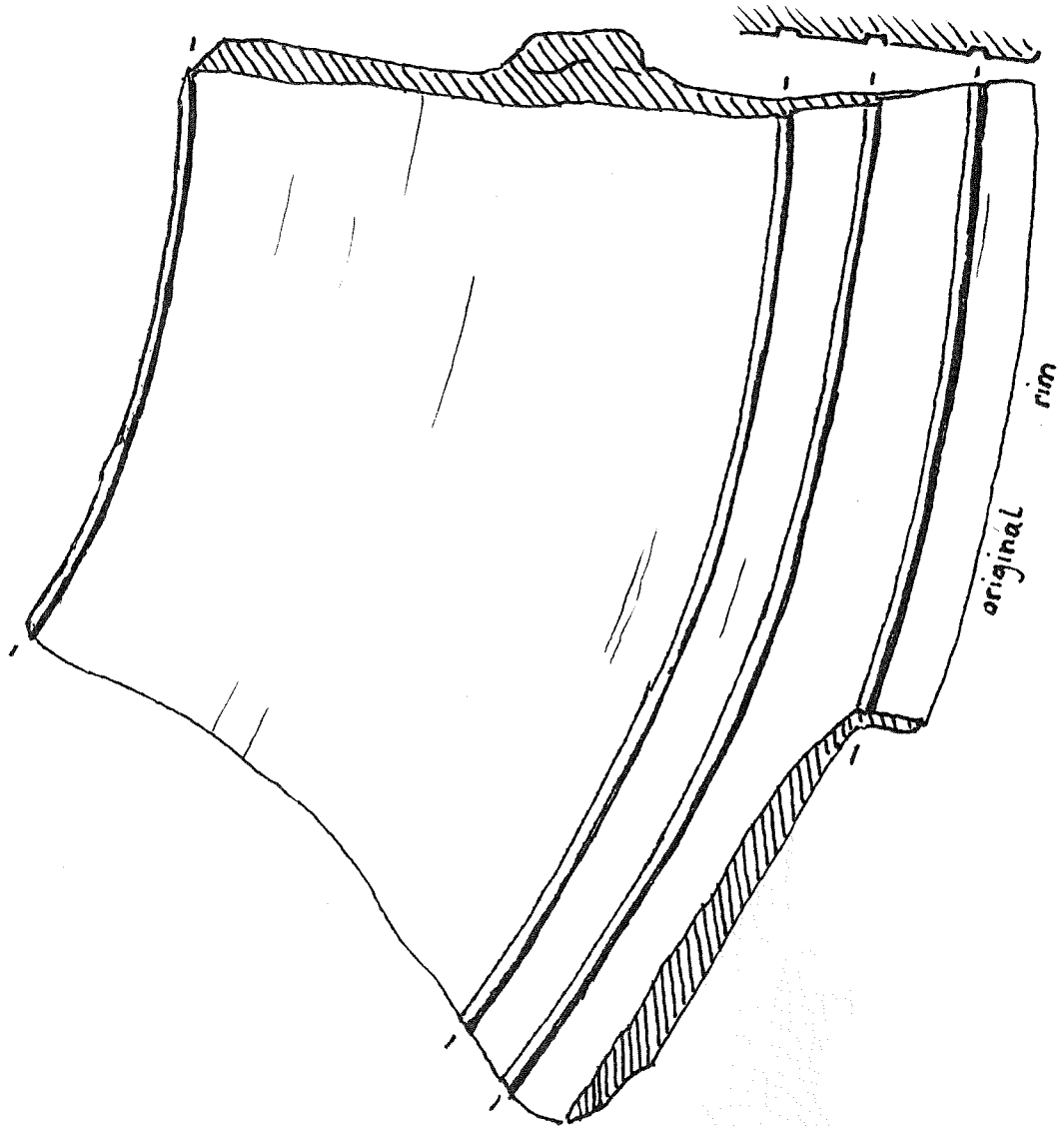

HS I Fragment from a platform like object (pottery wheel?)

Leaf 2

Scale 1:1

